

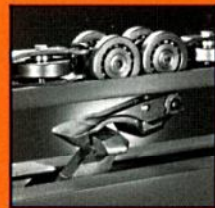

# **Rapid Industries, Inc.**

DESIGNERS • MANUFACTURERS • INSTALLERS

## **Rapid Trolley and Chain Components**



# Trolley Wheels

**6"** Rapid trolleys are offered in 6-inch, 4-inch, 3-inch and 2-inch sizes with a variety of options. The 6-inch, 4-inch and 3-inch trolleys are available in either full ball complement or retainer configurations. The full ball complement trolley wheel contains the maximum number of precision ball bearings and is designed for heavy duty and/or high heat applications. The retainer type trolley wheel has each precision ball bearing separated and equally spaced around the periphery of the bearing race by a two piece steel retainer cage. The retainer type wheel is designed primarily for transportation and parts delivery systems. It is generally not suited for heavy duty or high heat applications.



## Featuring Rapid Seals

The Rapid 'Dirt Stopper' seal is a triple labyrinth design with three (3) alternating shields to keep lubricants in and contamination out under normal operating conditions. Outer and inner shields rotate around the stationary middle shield forcing dirt to travel in five (5) directions before it can pass through the 'Dirt Stopper' seal protecting the grease supply in the bearing cavity.

Regular scheduled lubrication must be maintained on all Rapid trolley wheels for optimum performance and long life. The open wheel configuration with no seals or one seal on either side of the wheel is well suited for automatic spray mist lubrication. The Rapid 'Dirt Stopper' seal can be relubed either manually or automatically. Be sure to consult your lubrication supplier for the proper lubricant and *remember not to over lubricate.*

The inner and outer bearing raceways on both full ball complement and retainer type wheels are constructed from high quality carbon steel manufactured and heat treated to a minimum of Rockwell C-58 hardness for maximum performance, longer life and minimum maintenance. Both types of trolleys are swaged to the trolley bracket.

Rapid retainer type trolley wheels are offered with Rapid seals only. Rapid full ball complement trolley wheels are available with or without Rapid seals (sealed or open configuration). The open type configuration is used primarily for oven applications or where spray mist lubrication is desired.

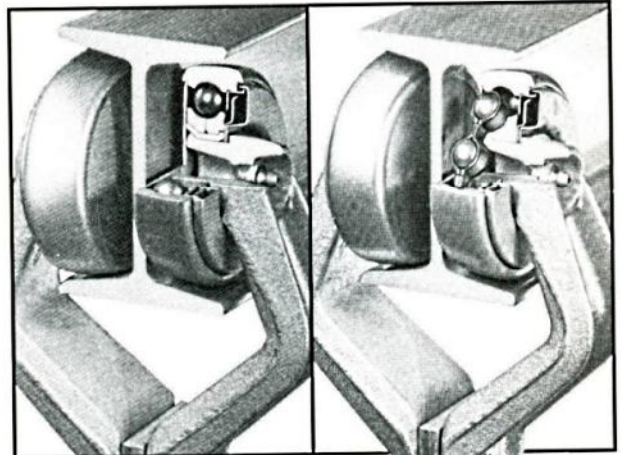



Photos and illustrations courtesy of Frost, Inc.

Drop forged, high strength steel brackets are attached to the wheels by riveting or swaging. All Rapid brackets are designed with a ribbed construction for maximum strength.



**2"** Rapid 228 trolleys are available in full ball complement with machined race ways with a single row of ball bearings. They have drop forged, zinc plated brackets. The full ball wheel with machined race ways are offered in sealed or open configuration. The brackets are attached to the wheels by bolting. The sealed style has a zerk fitting for re-lube. This trolley is an excellent performer in conditions up to 450°F.

Features	 <b>Full Ball (FBC)</b>	 <b>Retainer Type</b>
<b>ENERGY CONSIDERATION</b>	<b>Moderate Horsepower Required</b> Rapid standard FBC type trolley wheels are designed without a ball separator. Because of the ball-to-ball sliding contact and the demand for more chain pull, horsepower requirements are increased.	<b>Low Horsepower Required</b> Rapid retainer type trolley wheel construction is of the Conrad type (single row bearing with balls spaced apart by a coined steel ball separator). This wheel design (with balls separated) causes low friction and requires the least amount of conveyor drive horsepower.
<b>RACEWAY DESIGN</b>	<b>Split Inner Raceway, Hardened and Fully Contoured</b> Rapid standard FBC wheels have an extremely deep-groove, fully contoured inner raceway and can operate continuously under heavy (two-directional) radial and thrust loads. The construction advantages are: <ol style="list-style-type: none"> <li>1) High raceway shoulders for maximum thrust load capacity.</li> <li>2) Split inner raceway allows for deeper ball path and more balls for maximum load-carrying capability.</li> <li>3) The raceway rings have a double lock feature. This provides a positive, dual direction lock assuring that the split inner rings will not spread apart.</li> </ol> The raceways are case hardened to Rc 58 min. for maximum shock and wear capability.	<b>Non-Split Inner Raceway, Hardened and Fully Contoured</b> Rapid retainer type wheels have a one-piece inner raceway, fully contoured on both sides of the ball for light, continuous thrust and radial load carrying capability.  The raceways are case hardened to Rc 58 min. for maximum wear capability.
<b>INTERNAL FIT-UP</b>	<b>Greater Clearance</b> Rapid standard FBC wheels have greater internal raceway clearance for misalignment tolerance and to prevent bearing freeze-up due to dirt contamination and/or heat expansion. For higher temperatures and contamination, Rapid can provide one less ball, special materials or extra-grind upon request.	<b>Normal Clearance</b> Rapid retainer type wheels have normal internal radial fit-up and a ball separator to ensure smooth rolling operation, yet ample clearance for misalignment tolerance. For higher temperatures, a special, deep pocket design is available upon request.
<b>HEAT CAPABILITY</b>	<b>500° F (260° C) Continuous</b> Rapid standard FBC wheels were designed for continuous temperatures up to 500° F (260° C). For temperature applications above 500° F, Rapid should be informed so that extra internal clearances can be provided.	<b>325° F (162° C) Continuous</b> Rapid retainer type wheels can be safely used continuously up to 325° F (162° C). This limitation is due to less internal clearance for heat expansion of bearing components and for separator annealing.
<b>CONTAMINATION TOLERANCE</b>	<b>Heavy Contamination</b> Rapid standard FBC wheels can withstand heavy contamination level (dry or liquid) and operate best with Rapid Seals. Added contamination tolerance can be obtained by using Rapid Seal with wiper lip seal.	<b>Moderate Contamination</b> Rapid retainer type wheels can withstand moderate contamination levels. Medium levels and liquid contaminants can be tolerated by using Rapid Seal with wiper lip seal.
<b>LOAD CAPACITY</b>	<b>High Load Capacity</b> Rapid standard FBC wheels have greater load capacity than retainer type wheels due to the increased number of balls. Specifically designed for maximum load situations, standard FBC wheels can handle peak and continuous radial and thrust loads acting from any direction. They are the best choice for shock and impact loading. Note: In system design, I-beam is the limiting factor.	<b>Moderate Load Capacity</b> Rapid retainer type wheels have the highest load capacity of any available retainer type wheels. Although this capacity is exceeded by full ball complement wheels, retainer type wheels have ample load capacity for most conveyor systems. Note: In system design, I-beam is the limiting load factor.

# Trolley Sizes

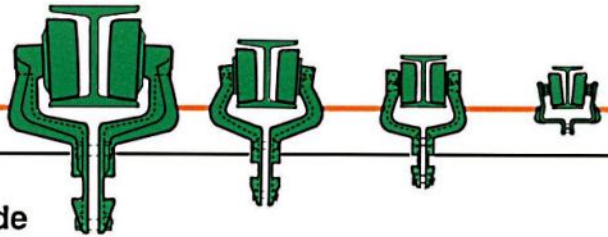

Rapid has a full line of trolleys and accessories to fit every application. By selecting the proper size and type of trolley, attachments, load bars and chain, Rapid can supply the components for an entire system ranging from a light duty, clean environment to an extremely heavy duty, harsh environment.

Select your system from the chart, or call our Engineering Department for quick, efficient solutions to your most complicated materials handling problems.

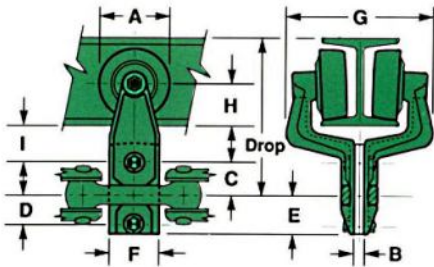

## Approx Wt./Ft.-Chain & Trolleys

Rapid 6" Trolleys - X678 Chain					
Trolley Spacing (in.)	12	24	36		
Weight Per Ft. (lbs.)	25.1	15.8	12.7		
Rapid 4" Trolleys - X458 Chain					
Trolley Spacing (in.)	8	16	24	32	
Weight Per Ft. (lbs.)	12.2	7.7	6.2	5.5	
Rapid 3" Trolleys - X348 Chain					
Trolley Spacing (in.)	6	12	18	24	30
Weight Per Ft. (lbs.)	8.3	5.2	4.2	3.7	3.4
Rapid 2" Trolleys - X228 Chain					
Trolley Spacing (in.)	8	12	16	20	24
Weight Per Ft. (lbs.)	3.0	2.7	2.4	2.1	1.8

Trolley Size Selection Guide		6"	4"	3"	2"	
Trolley Size		6"	4"	3"	2"	
Single Trolley Capacity		1200 lbs	400 lbs	200 lbs	125 lbs	
Trolley Capacity With Load Bar		2400 lbs	800 lbs	400 lbs	250 lbs	
Chain Size		X-678	X-458	X-348	X-228	
I-Beam		S6" x 12.5 lbs/ft.	S4" x 7.7 lbs/ft.	S3" x 5.7 lbs/ft.	S2 <sup>5</sup> / <sub>8</sub> " x 3.7 lbs/ft.	
Drop		10"	8"	7 <sup>3</sup> / <sub>16</sub> "	5 <sup>1</sup> / <sub>2</sub> "	4 <sup>1</sup> / <sub>2</sub> "
Trolley Dimension	A	4 <sup>13</sup> / <sub>16</sub> "	3 <sup>3</sup> / <sub>16</sub> "	3 <sup>3</sup> / <sub>16</sub> "	2 <sup>5</sup> / <sub>16</sub> "	1 <sup>15</sup> / <sub>16</sub> "
	B	1/2"	3/8"	3/8"	1/4"	1/4"
	C	1 <sup>5</sup> / <sub>8</sub> "	1 <sup>5</sup> / <sub>16</sub> "	1 <sup>5</sup> / <sub>16</sub> "	1"	-
	D	1 <sup>1</sup> / <sub>8</sub> "	1 <sup>3</sup> / <sub>16</sub> "	1 <sup>3</sup> / <sub>16</sub> "	7/8"	-
	E	1 <sup>11</sup> / <sub>16</sub> "	1 <sup>1</sup> / <sub>4</sub> "	1 <sup>5</sup> / <sub>16</sub> "	1 <sup>1</sup> / <sub>4</sub> "	-
	F	3 <sup>3</sup> / <sub>8</sub> "	2 <sup>1</sup> / <sub>8</sub> "	2 <sup>1</sup> / <sub>8</sub> "	1 <sup>9</sup> / <sub>16</sub> "	1"
	G	6 <sup>7</sup> / <sub>8</sub> "	5 <sup>3</sup> / <sub>8</sub> "	5 <sup>3</sup> / <sub>8</sub> "	4 <sup>1</sup> / <sub>16</sub> "	4 <sup>11</sup> / <sub>16</sub> "
	H	2 <sup>11</sup> / <sub>16</sub> "	1 <sup>7</sup> / <sub>8</sub> "	1 <sup>7</sup> / <sub>8</sub> "	1 <sup>7</sup> / <sub>16</sub> "	1 <sup>3</sup> / <sub>16</sub> "
	I	2 <sup>3</sup> / <sub>8</sub> "	2 <sup>11</sup> / <sub>16</sub> "	1 <sup>7</sup> / <sub>8</sub> "	1 <sup>1</sup> / <sub>2</sub> "	-

## Chain

Drop forged rivetless chain for Power Only and Power and Free conveyors, has a high strength to weight ratio, is extremely flexible in both horizontal and vertical planes, is easy to assemble without tools, and remains intact while in service with minimum maintenance.

X-Type Rivetless (6", 4", 3")

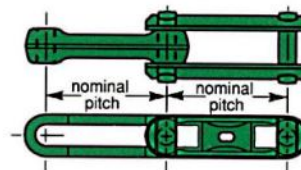

Regular Rivetless (2")

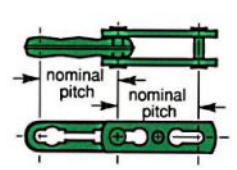

Nominal Pitch (Theoretical)	Part No.	Ultimate Strength Pounds x 1000	Assembled Weight Pounds Per Foot	Horizontal Turns - Min. Sizes			Chain Pull Capacity		Verticle Curves - Minimum Radius								
				Type	Light C.P.	Maximum C.P.	Recommended Max. Chain pull for long life	Maximum Chain Pull Intermittent	Trolley Spacing (inches)								
									8	12	16	18	20	24	30	32	36
6"	X678	85	6.7	Roller Wheel	36" Rad. 36" Dia.	48" Rad. 48" Dia.	4500 lbs	6500 lbs	-	12ft.	-	-	-	15ft.	-	-	20ft.
4"	X458	48	3.2	Roller Wheel	18" Rad. 24" Dia.	24" Rad. 36" Dia.	2500 lbs	3500 lbs	-	-	8ft.	-	-	10ft.	-	12ft.	-
3"	X348	24	2.2	Roller Wheel	18" Rad. 24" Dia.	18" Rad. 24" Dia.	1500 lbs	2000 lbs	-	5ft.	-	8ft.	-	8ft.	10ft.	-	-
2"	X228	6	.75	Roller Wheel	18" Rad. 12" Dia.	24" Rad. 36" Dia.	400 lbs	600 lbs	2ft.	3ft.	4ft.	-	6ft.	8ft.	-	-	-

## Trolley Ordering Guide

Ref. Number	Trolley Size	Wheel Type	Bracket Type	Attachment Hole Pattern	Chain Size	Connection to Bracket	Drop From Top of Track	
601	<b>6"</b>	Sealed Retainer	Forged	Vertical	X678	Swaged	10" (254.0)	
602		Sealed Retainer	Forged	Horizontal	X458	Swaged	10" (254.0)	
603		Sealed Ret. w/Wiper	Forged	Vertical	X678	Swaged	10" (254.0)	
604		Sealed Ret. w/Wiper	Forged	Horizontal	X458	Swaged	10" (254.0)	
605		Open FBC	Forged	Vertical	X678	Swaged	10" (254.0)	
606		Open FBC	Forged	Horizontal	X458	Swaged	10" (254.0)	
607		Sealed FBC	Forged	Vertical	X678	Swaged	10" (254.0)	
608		Sealed FBC	Forged	Horizontal	X458	Swaged	10" (254.0)	
609		Sealed FBC w/Wiper	Forged	Vertical	X678	Swaged	10" (254.0)	
610		Sealed FBC w/Wiper	Forged	Horizontal	X458	Swaged	10" (254.0)	
401	<b>4"</b>	Sealed Retainer	Forged	Vertical	X458	Swaged	8" (203.2)	
402		Sealed Retainer	Forged	Vertical	X458	Swaged	7 <sup>3</sup> / <sub>16</sub> " (182.6)	
403		Sealed Retainer	Forged	Vertical	X678	Swaged	7 <sup>7</sup> / <sub>16</sub> " (188.9)	
404		Sealed Retainer	Forged	Horizontal	X458	Swaged	8" (203.2)	
407		Open FBC	Forged	Vertical	X458	Swaged	8" (203.2)	
408		Open FBC	Forged	Vertical	X458	Swaged	7 <sup>3</sup> / <sub>16</sub> " (182.6)	
409		Open FBC	Forged	Vertical	X678	Swaged	7 <sup>7</sup> / <sub>16</sub> " (188.9)	
410		Open FBC	Forged	Horizontal	X458	Swaged	8" (203.2)	
411		Sealed FBC	Forged	Vertical	X458	Swaged	8" (203.2)	
412		Sealed FBC	Forged	Vertical	X458	Swaged	7 <sup>3</sup> / <sub>16</sub> " (182.6)	
413		Sealed FBC	Forged	Vertical	X678	Swaged	7 <sup>7</sup> / <sub>16</sub> " (188.9)	
414		Sealed FBC	Forged	Horizontal	X458	Swaged	8" (203.2)	
303		<b>3"</b>	Sealed Retainer	Forged	Vertical	X348	Swaged	5 <sup>1</sup> / <sub>2</sub> " (139.7)
304			Open FBC	Forged	Vertical	X348	Swaged	5 <sup>1</sup> / <sub>2</sub> " (139.7)
305	Sealed FBC		Forged	Vertical	X348	Swaged	5 <sup>1</sup> / <sub>2</sub> " (139.7)	
202	<b>2"</b>	Open FBC	Forged	Vertical	X228	Bolted	4 <sup>1</sup> / <sub>2</sub> " (114.3)	
203		Sealed FBC	Forged	Vertical	X228	Bolted	4 <sup>1</sup> / <sub>2</sub> " (114.3)	

# Attachments

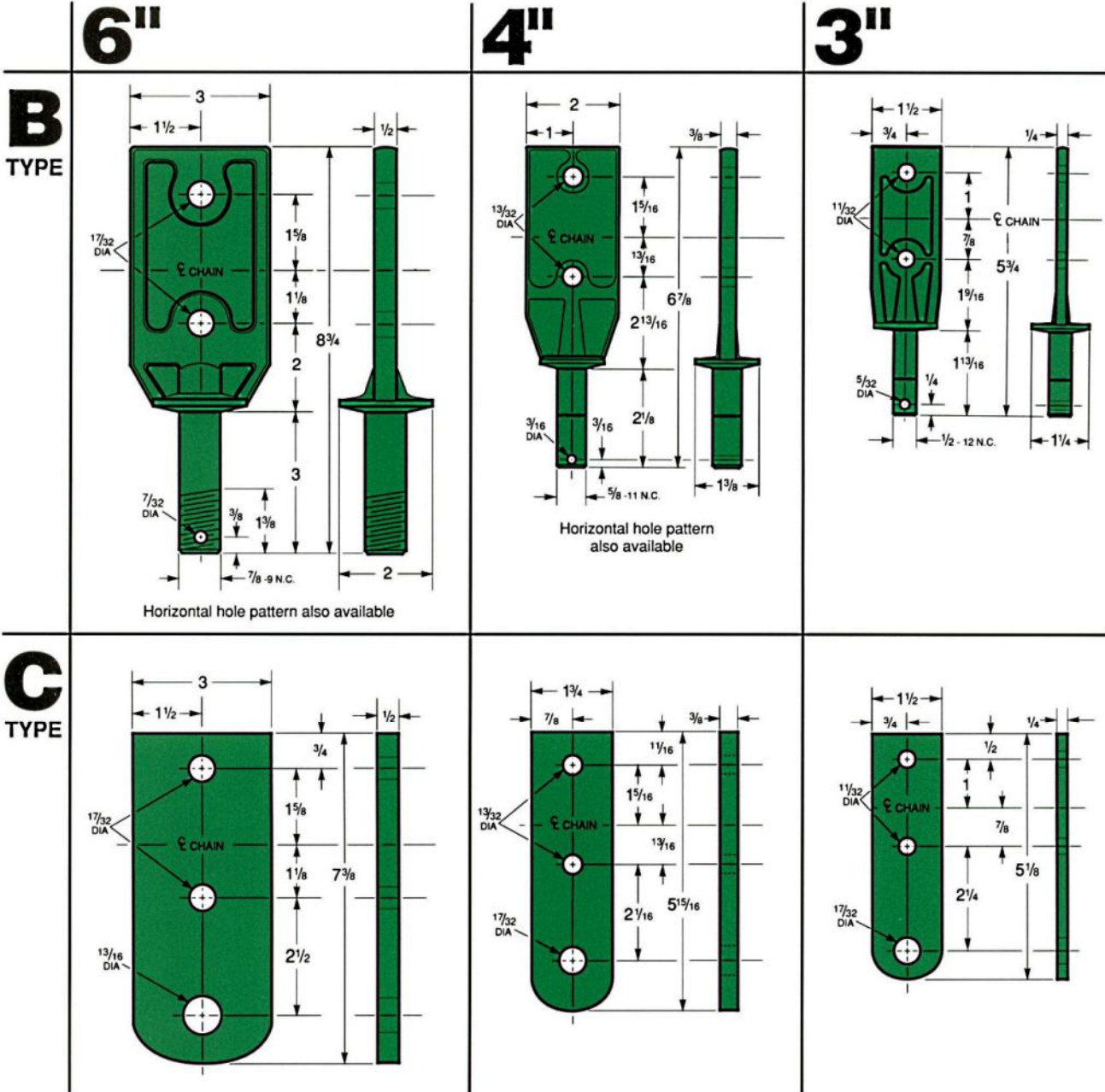

All dimensions are approximate

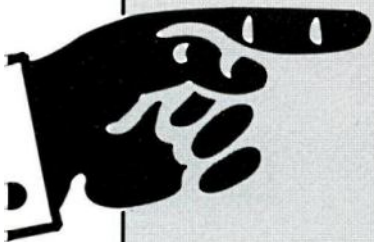

## Hand Pushed Trolley

### One-Ton Capacity Trolley

Rapid hand push trolleys for overhead monorail cranes and hoists are available in load ranges up to 1 ton. These versatile trolleys are adaptable to fit different sized I-beams and utilize Splashproof seals for contaminated environments. Choose the size you need from the table.

Rail Size	A	B	C	D	E
4"	3-29/64	1-45/64	3-3/4	4-41/64	1-29/32
5"	3-41/64	2-5/64	3-3/4	4-41/64	1-57/64
6"	3-53/64	2-15/32	3-3/4	4-41/64	1-7/8
8"	4-7/32	3-7/32	3-3/4	4-41/64	1-27/32

All dimensions are approximate

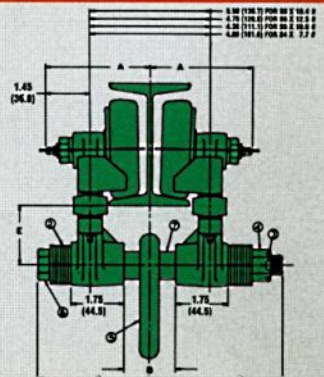

# Attachments

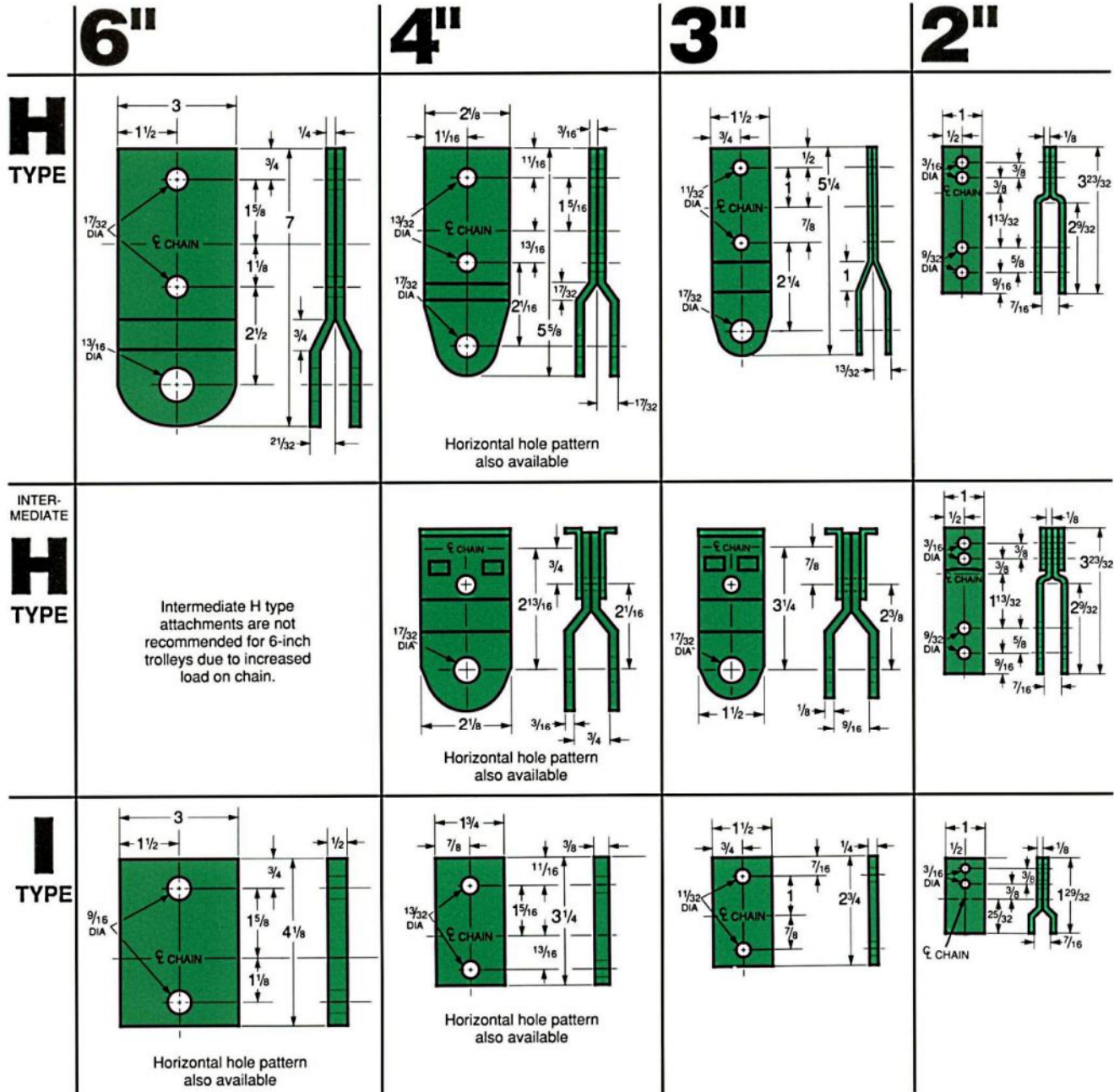

All dimensions are approximate

## 500 Pound Capacity Trolley

For lighter duty applications the 500 pound capacity hand push trolley will run on 2", 3" or 4" I-beams. These trolleys are precision built and run smooth on radii down to 12".

Hand Pushed Trolley Assembly - #9792		
Assy No.	Amt.	Description
1	2	Half Trolley Assembly - #9792-1
2	1	1/2" Bolt - #8571
3	1	Cotter Pin 1/8" x 1-1/4" Long
4	1	1/2" Dia. Finished Hex Slotted Nut
5	1	Load Link - #8147
6	10	1/2" S.A.E. Washers

All dimensions are approximate

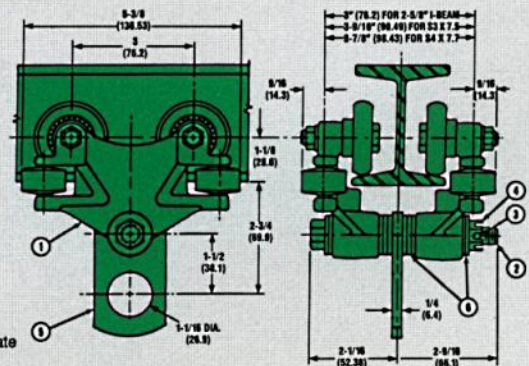

# Load Bar Assemblies

**6"** Load bar assembly for 6" I-beam by X-678 chain has a capacity of 2400 pounds. Order load bar or load bar assembly composed of:

- (A) 1 - 6" Load Bar
- (B) 2 - 6" B Attachments
- (C) 2 - Spherical Washers
- (D) 2 - Tube Spacers
- (E) 2 - Slotted Hex Nuts
- (F) 2 - Cotter Pins

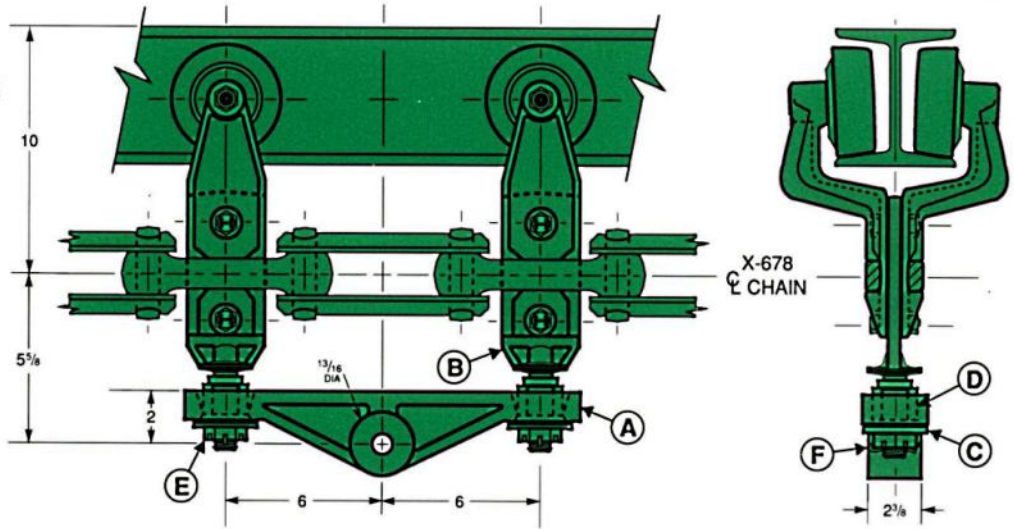

**4"** Load bar assembly for 4" I-beam by X-458 chain has a capacity of 800 pounds. Order load bar or load bar assembly composed of:

- (A) 1 - 4" Load Bar
- (B) 2 - 4" B Attachments
- (C) 2 - Spherical Washers
- (D) 2 - Tube Spacers
- (E) 2 - Slotted Hex Nuts
- (F) 2 - Cotter Pins

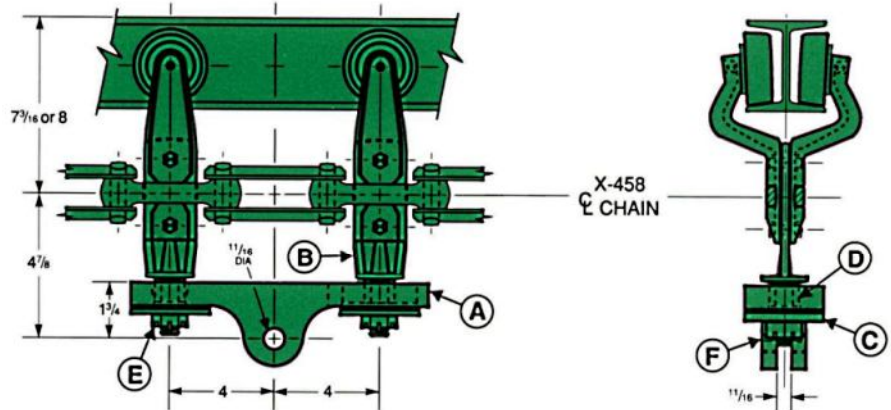

**3"** Load bar assembly for 3" I-beam by X-348 chain has a capacity of 400 pounds. Order load bar or load bar assembly composed of:

- (A) 1 - 3" Load Bar
- (B) 2 - 3" B Attachments
- (C) 2 - Spherical Washers
- (D) 2 - Tube Spacers
- (E) 2 - Slotted Hex Nuts
- (F) 2 - Cotter Pins

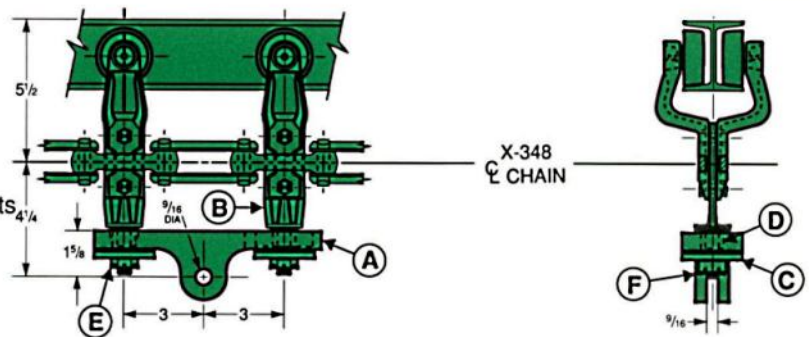

**2"** Load bar assembly for 2-5/8" I-beam by X-228 chain has a capacity of 250 pounds. Order load bar or load bar assembly composed of:

- (A) 1 - 2" Load Bar
- (B) 2 - 2" H Attachments
- (C) 2 - Spherical Washers
- (D) 2 - Tube Spacers
- (E) 2 - Slotted Hex Nuts
- (F) 2 - Cotter Pins
- (G) 2 - Swivel Attachments

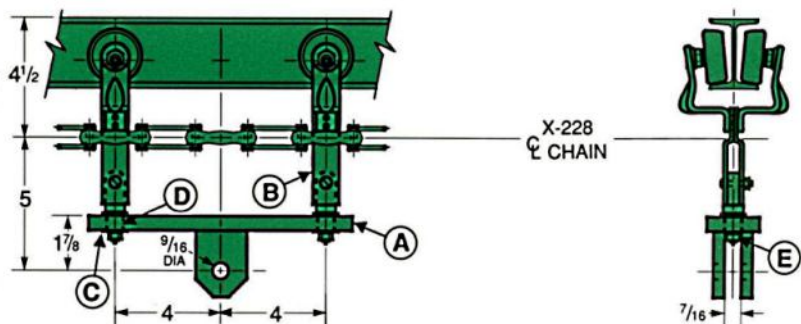



# Accessories

## Rollers

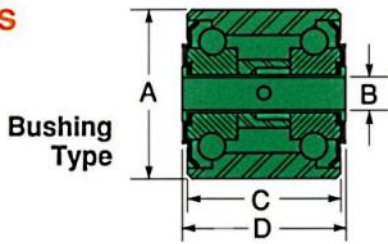

Rail Size	Part Number	A O.D.	B Bore	C Face	D Overall	Relubrication Thru	Bearing Weight	To be used with Bolt:
2"	232	1-3/4"	1/4"	1-3/8"	1-1/2"	Grease packed	.75 lbs.	1/4-20 x 2-1/4 Flat head cap screw-or 1/4-20 x 2-3/4 Socket head cap screw
2"	390	2-1/8"	1/4"	1-3/8"	1-1/2"	Center Pin	1.0 lbs.	(Drilled w/Zerk for 390 only) Part No. 3007-8
3"	3051	2-3/4"	1/2"	1-15/16"	2-1/8"	Center Pin	2.4 lbs.	Part No. 4003-8
4" & 6"	4051	2-3/4"	1/2"	2-9/16"	2-3/4"	Center Pin	3.1 lbs.	Part No. 4012-61
4"	4057	2-3/4"	9/16"	2-9/16"	2-3/4"	Center Pin	3.1 lbs.	Part No. 4255-8
4"	4072	2-3/4"	5/8"	2-9/16"	2-3/4"	Center Pin	3.1 lbs.	Part No. 4255-8

## Pins

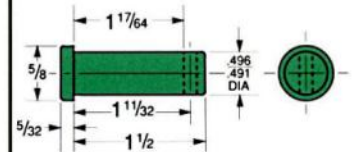

Clevis Pin

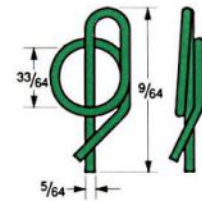

Safety Pin

## Roller Bolts

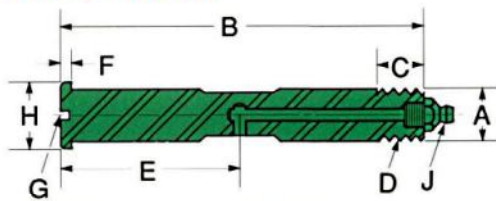

Part No.	A	B	C	D	E	F	G	H	J
3007-8	1/2"	3 1/2"	1/2"	1/2"-13	1 9/16"	1/8"	3/32" x 3/32"	11/16"	1641-B
4003-8	1/2"	4 5/32"	5/8"	1/2"-13	1 7/8"	1/8"	3/32" x 3/32"	11/16"	1641-B
4012-61	9/16"	4 3/16"	5/8"	9/16"-18	2 1/16"	1/8"	3/32" x 3/32"	3/4"	1641-B
4255-8	5/8"	4 5/32"	1/2"	5/8"-11	1 7/8"	1/8"	3/32" x 3/32"	13/16"	1641-B

## Hooks

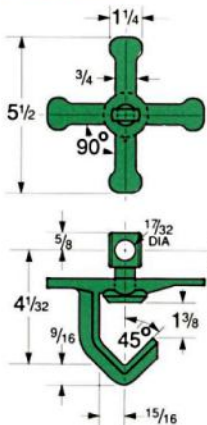

**90° Star Indexing Swivel**  
The Rapid star wheel indexing swivel has a 125 pound capacity rating and can be used with X-348 and X-458 trolley H attachments.

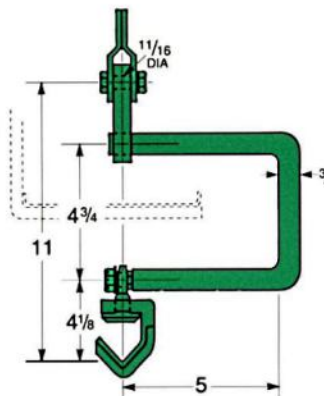

**Rapid Sanitary Hook Assembly**  
Rapid sanitary hook assemblies have a maximum 250 pound capacity and can be used in either indexing or non-indexing applications.

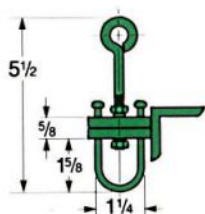

**Friction Turning Hook**  
Rapid friction turning hooks have a 75 pound capacity and rotate work by riding against a turn rail.

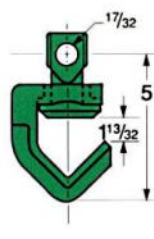

**90° Indexing Swivel Hook**  
Rapid indexing swivel hooks have a 300 pound capacity and work with 3" and 4" tracks. 90° index - 180° transverse to chain; 180° parallel to chain.

## Trolley Bolts

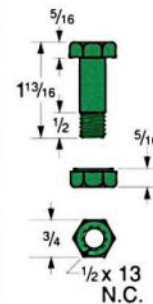

For 6" Trolley

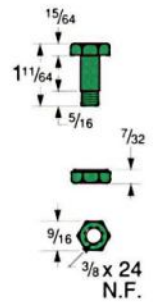

For 4" Trolley

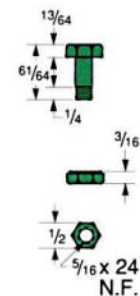

For 3" Trolley

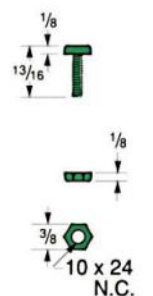

For 2" Trolley

# Rapid Flex™ Enclosed Track System

The Rapid Enclosed Track Overhead Conveyor is a cost-effective alternative for moving light loads in almost any environment. By using an over/under loop configuration, a 90° twist or a 90° vertical incline, Rapid can meet almost any design requirement without costly customization. Many

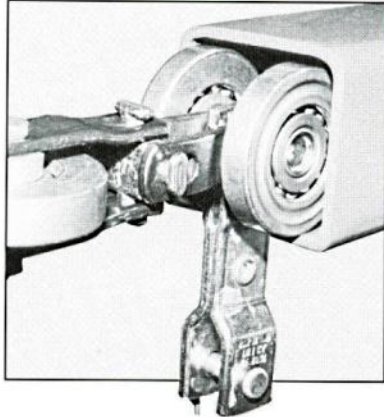

customers find the ease of installation an extra bonus in purchasing a Rapid Enclosed Track.

## Rapid Flex™ Chain Assembly

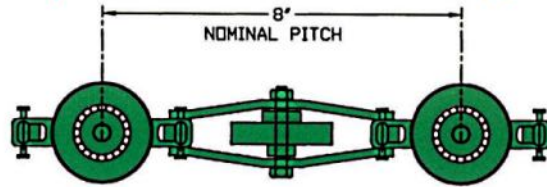

Strength and flexibility are built into all Rapid Chain Assemblies. Chain is shipped in 20 ft. lengths and can be assembled with common hand tools.

RF-0102 - Heavy Duty (WT. 3.65#/FT.)

## Rapid Flex™ 4-Wheel Pusher Dog/Chain Attachment

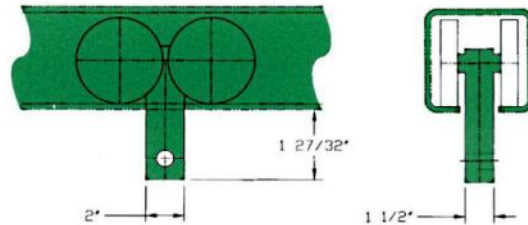

For those heavy loads, Rapid 4-Wheel Pusher Dog/Chain Attachment can be built into the Rapid chain (250 lbs. capacity). With a Rapid Power & Free System, this system has the power and flexibility to handle the most complex operations easily.

RF-2100

## Rapid Flex™ Track Section

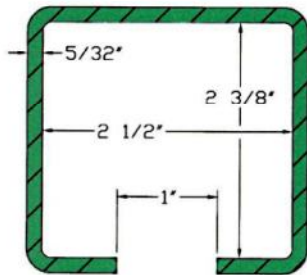

Design flexibility, ease of installation, and low maintenance are all features of the Rapid Enclosed Track. Formed with high strength steel, each 20'-0" section can be cut and welded without using any special equipment to fit almost any situation.

RF-0800 (WT. 5#/FT.) Straight Track Section

## Rapid Flex™ Hand Pushed Trolley

### 250 Pound Capacity Trolley

High strength cast body with heavy duty load wheels, provide long trolley life under adverse conditions. Load capacity may be increased up to 1000 lbs. by using additional trolleys connected in tandem with load bars.

RF-2000

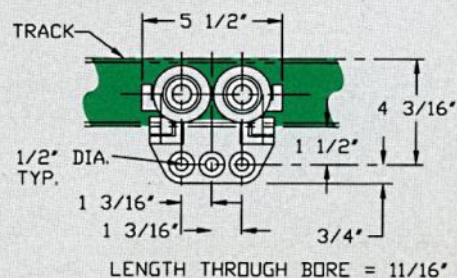

All dimensions are approximate



## Accessories

### Rapid Flex™ Swivel Rotator



The swivel rotator can be rotated by hand or automatically with rub rail installed.

RF-0204

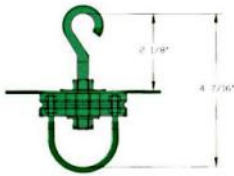

Positive rotation can be provided by adding a six point star to the swivel rotator.

RF-0205

### Rapid Flex™ 90° Indexing Hook

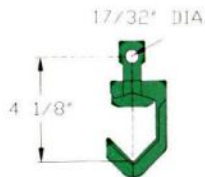

Two piece cam construction provides positive 90° indexing.

RF-0206

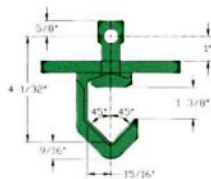

Automatic indexing can be achieved by adding a four point star to the standard hook.

RF-0207

## Attachments

### Rapid Flex™ Standard "H" Attachment

75 lbs. capacity

RF-0201

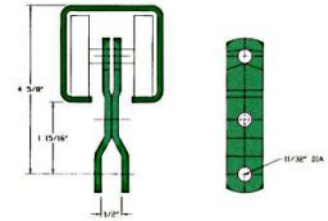

### Rapid Flex™ Rigid "H" Attachment

75 lbs. capacity

RF-0202

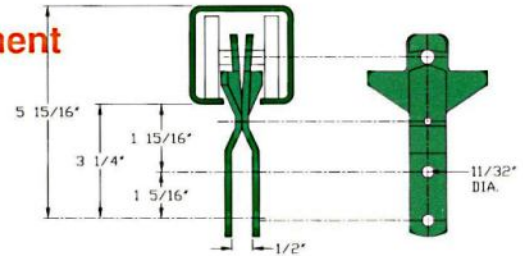

### Rapid Flex™ Extended "H"

75 lbs. capacity with minimum radius of 24"

RF-0203

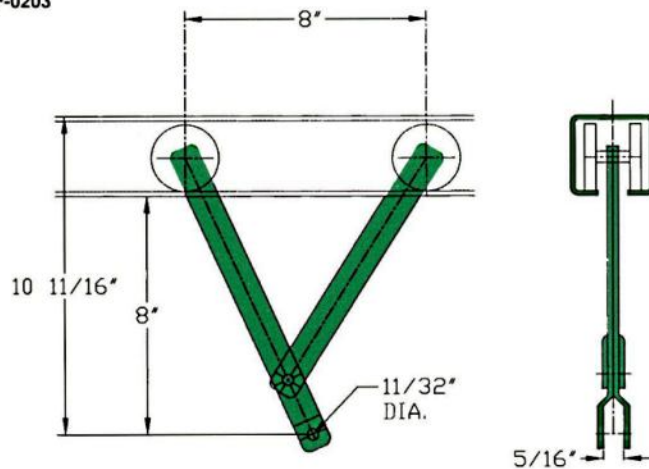

## Load Bar Assemblies

### Rapid Flex™ 150 lb Capacity Load Bar

By suspending the load bar from two "H" attachments, the load capacity can be increased.

RF-0301

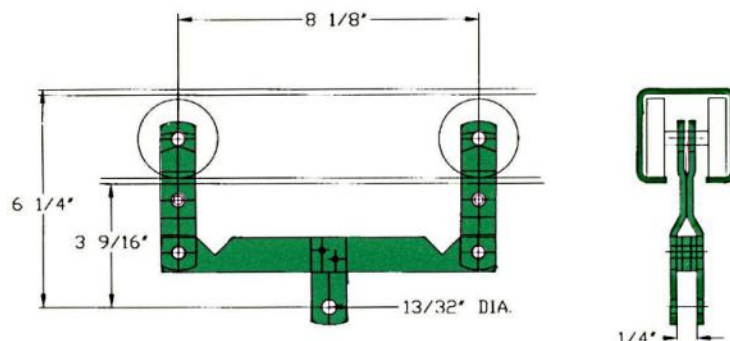



## **Rapid Industries, Inc.**

4003 Oaklawn Dr. • P.O. Box 19259 • Louisville, KY 40259-0259  
(502) 968-3645 • Fax: (502) 968-6331  
**1-800-RAPID81 • Fax 1-888-225-3564**  
[www.rapidi.com](http://www.rapidi.com)

